

Science with Passion



AZURA[®] Analytical ULDC/UHPLC



The most flexible HPLC platform.

think **LC.** think **KNAUER.**

Let your application define your system solution.

In HPLC, components of a mixture are carried through the stationary phase by the flow of a mobile phase and separation is based on differences in

migration rates among the sample components. Therefore, the nature of your analytes defines not only the method but also the HPLC system.

Main characteristics of the analytes:

MOLECULAR WEIGHT defines the pore size of the stationary phase.

SOLUBILITY defines the HPLC mode, chemistry of stationary phase and eluent.

CONCENTRATION AND MATRIX defines the detection parameters and column dimensions.



The solubility of your analytes defines the HPLC mode. The elutropic series defines the solvent strength for the most often used chromatography modes normal phase and reversed phase.



Most common HPLC modes

HPLC mode	Mobile phase	Stationary phase	Analytes
Separation of small molecules (up to 2000 Da)			
Reversed Phase RP (<200 Å)	Polar (e.g. mixtures from water and acetonitrile)	Nonpolar (e.g. C18)	Mid-polar - mid-nonpolar soluble in polar and aqueous solvents
Normal Phase NP	Nonpolar (e.g. heptan)	Polar (e.g. SiOH)	Nonpolar soluble in nonpolar solvents, insoluble in water
Hydrophilic Interaction Liquid Chromatography HILIC	Polar organic solvents + water	Polar (e.g. SiOH)	hydrophilic and highly polar not retained by RP
<p>Water layer between stationary and mobile phase</p>			
Separation of biomolecules (larger than 2000 Da)			
Wide Pore Reversed phase RP (>200 Å)	Polar	Nonpolar	Mid-polar - mid-nonpolar soluble in polar and aqueous solvents
Polymer gel based stationary phases			
Ion Exclusion & Ligand exchange	Water, acidic water	Organic resin with charged groups	Sugars, organic acids, alcohols

AZURA® Analytical HPLC/UHPLC

Efficient and adaptable to your needs

The analytical HPLC and UHPLC systems of the KNAUER AZURA liquid chromatography instruments are designed to support and facilitate your work. Whether doing routine analysis or demanding separation tasks, AZURA systems are the right

tool to overcome your analytical challenges. Choose between different gradient forming technologies and maximum flow rates to find the best configuration for your task.

Most flexible
system configurations



Supporting **OpenLAB**,
ClarityChrom® and
Chromleon™



Matching **detectors**
according to
your analytes



Features

- Isocratic binary high pressure gradient (HPG) or quaternary low pressure gradient (LPG) pump
- Pump heads allowing flow rates up to 10 ml/min at 862 bar or 1240 bar up to 2 ml/min
- Autosampler with 0.1 µl sample aspiration at max. 1240 bar with zero sample loss
- Choice of highly sensitive UVD, MWD, DAD, or RID detectors with intelligent temperature control
- Wide range of flow cells available, including remote cells
- Finger-tight high pressure stainless steel capillary connections "K-Connect"
- Extensive safety features such as leak management and sensors
- Frontal access of detector lamp and pump head for easy maintenance

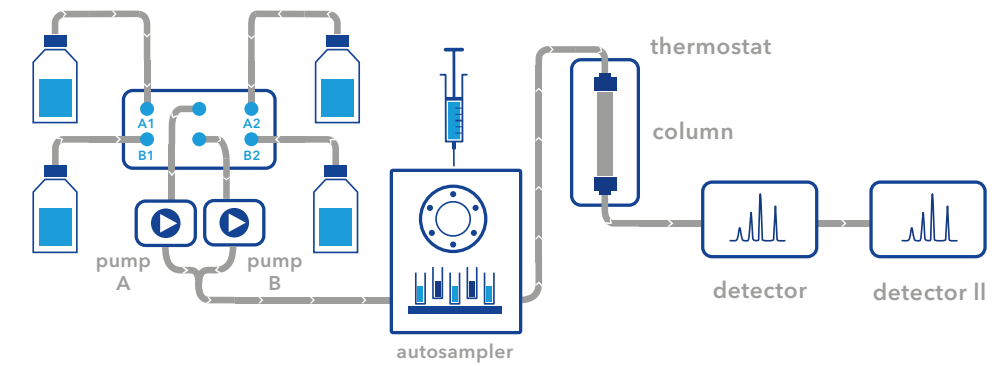

Eluent delivery
A choice of pumps available in different flow rates and pressure ratings

Detection
Various detector types (UV/VIS, DAD, RI) and flow cells

Injection modules
Automatic or manual injection

Tempering
Column thermostats and column switching solutions



Gradient HPLC

Pros and cons of HPG and LPG

HPG (Binary HPG pump)	LPG (Quaternary LPG pump)
Small gradient delay volume	Higher gradient delay volume
Fast methods	For classical HPLC methods: no difference For UHPLC: slower gradients
Only binary gradients possible	Ternary and quaternary gradients possible
2 pumps that have to be maintained	Only 1 pump, but shorter maintenance intervals because of higher usage

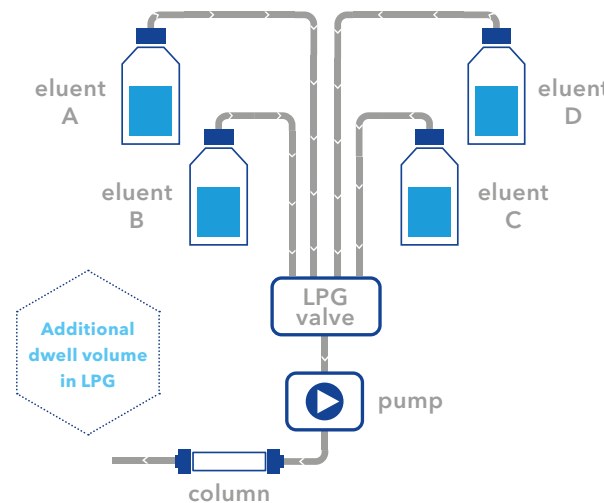
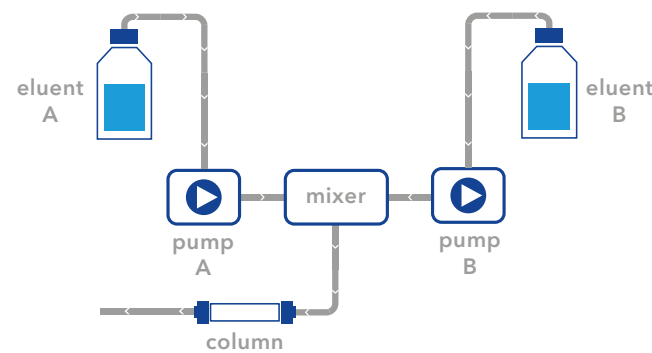

The dwell volume

The dwell volume is responsible for the time delay of a gradient. By definition it is the volume of a gradient HPLC system between the mixing device and the column inlet. It is typically higher in LPG systems, because the volume from the LPG valve to the mixer also contributes to the delay. Therefore, gradients can typically be run faster/steeper in HPG systems.



Whether an LPG or an HPG pump is recommended highly depends on the user's preferences. Only if very fast UHPLC gradients are needed, an HPG will be recommended. If a quaternary gradient is inevitable, an LPG pump has to be applied. **In any other case: The user decides!**

AZURA® Pump P 6.1L

Choose your HPLC pump according to your application's needs. Gradient formation, mixer size and pulsation compensation will have an extensive influence. Choose between pump heads with a maximum flow rate of 10 ml/min and 862 bar back pressure,

or pump heads with a flow rate of 5 ml/min and 1000 bar backpressure. Special pump heads for normal phase applications will help to deliver robustly even demanding eluents like heptane or hexane. Pumps without a degasser offer a cost effective alternative.

- AZURA® pump filter** protects the column from contamination.
- Piston seal wash** will clean the back piston space for longer seal life.
- Solvent selection valve** is integrated in every binary HPG pump. Each channel can be used with two different solvents.
- 2- or 4-channel online degasser** eliminates gas bubbles and reduces baseline noise, resulting in a higher sensitivity.

P 6.1L
HPG

AZURA® mixer

Highly efficient microfluidic solvent mixer combines high mixing performance with a low dead volume. The user-changeable mixer is available in different volumes (50/100/200/400/600 µl) allowing best possible adaption to any application.

- Multi-proportioning valve** will precisely blend up to 4 eluents.

P 6.1L
LPG

AZURA® Pump P 8.1L

Our new flagship: the 1 240 bar UHPLC pump P 8.1L. The patented advanced piston drive technology delivers unrivaled precision and stability in performance. Due to its unique mechanical solution and improved drive movements, the P 8.1L features a flow rate accuracy and residual pulsation superior to most competing UHPLC pumps.

KNAUER is a well-known manufacturer of analytical HPLC systems with decades of experience in the design and production of dual-piston pumps. Our hardware and software engineers, scientists, and application specialists are continuously improving the performance and durability of KNAUER HPLC pumps. The patented UHPLC pump mechanism of the P 8.1L represents a milestone in these efforts.

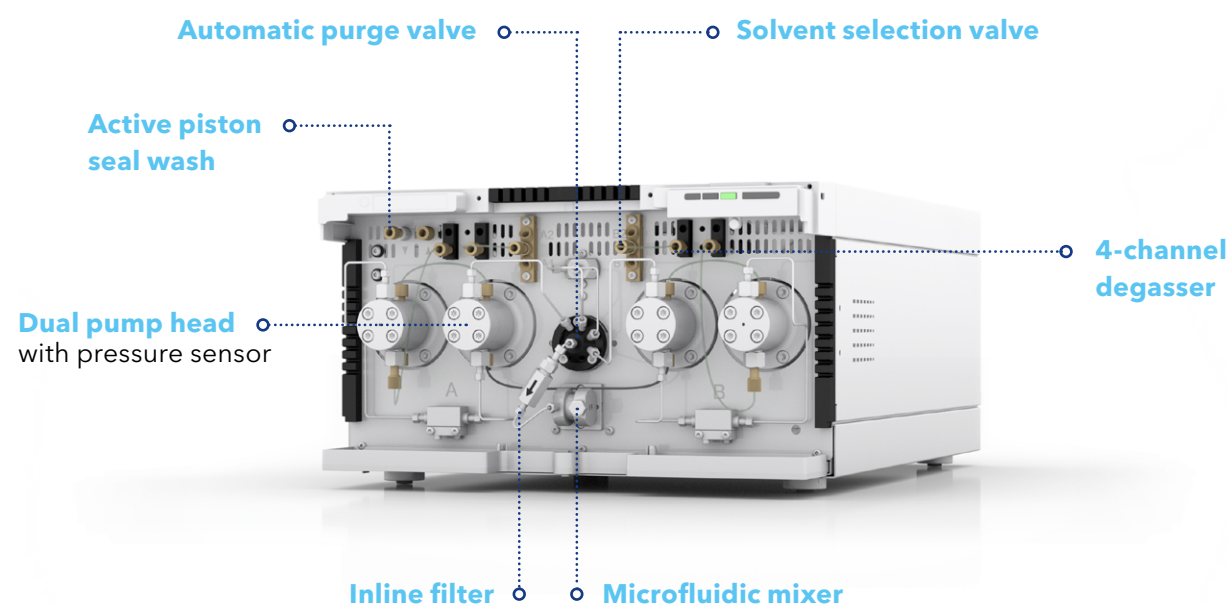

For the development of P 8.1L, all crucial components have been redesigned from scratch and we had to abandon some tradition. The patented high-precision drive is based on advanced piston drive technology. KNAUER's approach to use a unique mechanical solution and improved drive movements open novel options to control the precision of eluent delivery. The innovative drive design allows individual control for each piston over all relevant parameters like stroke length, acceleration, and velocity. The level of manufacturing precision

results in extraordinary ruggedness of the drive. To enable full control over the piston movement, KNAUER had to change the pump head assembly in favor of a single-piston pump head design. The patented drive assembly guarantees a perfect linear movement of each piston, which results in extremely low pulsation and an unmatched piston seal life. An additional pressure sensor between the two pump heads allows monitoring of the pre-compression phase and adaptation to eluent compressibility.

Features

- Maximum delivery pressure of up to 124 MPa/1 240 bar for ultra-fast and high-resolution applications
- Variable piston stroke for low baseline noise
- Adaptive pulsation compensation independent of flow rate, backpressure, and eluent type
- Microfluidic mixer for high mixing efficiency
- Real-time eluent compressibility adaption prevents user errors
- Automatic purging for seamless switching between different methods
- Unchanged footprint allows easy integration into existing AZURA systems

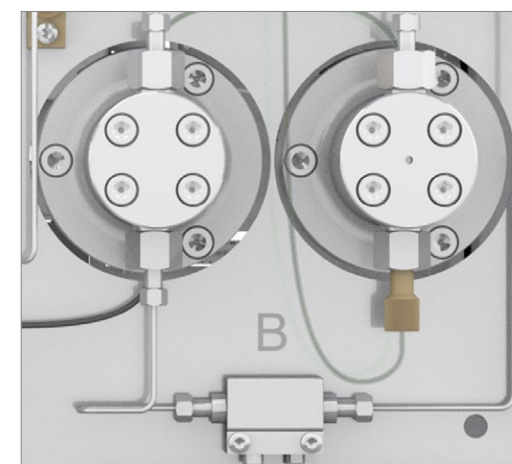

Dual pump head with independent piston drives and auxiliary pressure sensor

Outstanding performance – always

The pump P 8.1L offers an adaptive pulsation compensation independent of flow rate, backpressure, and eluent type through real-time eluent compressibility monitoring and variable piston stroke. Together with the ultra-precise piston movement thanks to KNAUER's proprietary advanced piston drive technology, this results in outstanding flow reproducibility. The microfluidic mixing device for highest mixing efficiency and lowest delay volume, minimizes associated UV noise and baseline ripple.

Seamless switching of methods

The AZURA P 8.1L features two solvent selection valves and an integrated 4-channel degasser. Together with the automatic purge valve seamless switching between different methods is easily possible. Thanks to the auxiliary pressure sensors the eluent-specific compressibility factors are calculated fully automated, without the user having to interfere with the CDS. The variable stroke volume allows efficient low-volume mixing for highest method flexibility.

Unsurpassed ruggedness

Developed with innovative technology and decades of continuous improvements the AZURA® Pump P 8.1L enters a new level of performance and durability. With a high level of in-house component production KNAUER achieves an industry-leading level of manufacturing precision. This results in unmatched piston seal life and system uptime.

For specifications see the "Technical data" section >>

Sample injection

Principle of manual injection

Manual injection valves are the most cost-effective option to introduce samples. Normally, valves with 6 ports and 2 positions - for loading and injection - are used. In the load position a sample loop is filled with sample while the system is equilibrating. When turning to the inject position, the sample loop is switched to the high pressure part of the HPLC system. The flow delivered by the pump flows through the loop and feeds the sample onto the column.

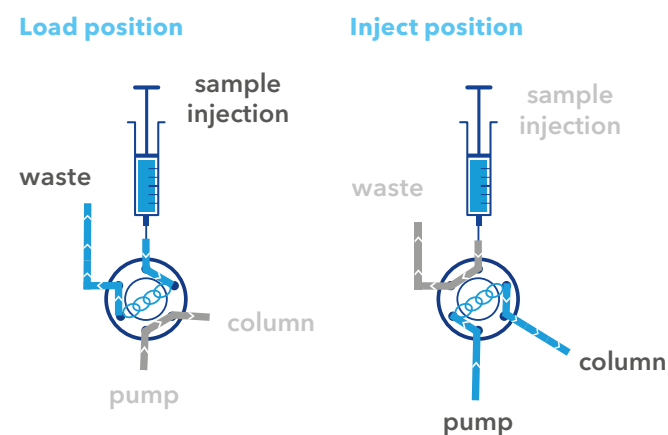

KNAUER valves feature a wide back pressure range of up to 1240 bar with a 0.3 mm bore size. All valves can be equipped with an automatic valve drive. In addition, an integration into the assistant module housing AZURA ASM 2.2L is possible. For automated injection of up to 108 different samples, we recommend to use an autosampler. The KNAUER AS 6.1L also works with an injection valve and a sample loop, but features several injection modes as described below.

Injection modes of the autosampler AS 6.1L

Device	Key features
Full loop	<ul style="list-style-type: none"> • Sample loop is completely filled with the sample. • Maximum reproducibility but not the maximum accuracy is achieved because the size of the sample loop may have a deviation. • Maximum injection volume equals the loop volume. • Sample loss caused by the need of overfilling of the loop.
Partial loop	<ul style="list-style-type: none"> • Sample loop is filled with both sample and mobile solvent. • High precision of the sample volume with minimal loss of sample • Maximum injection volume equals 50 % of the loop volume • Sample loss per injection equals the adjusted flush volume plus three times the sample volume for the syringe used.
Microliter pick-up	<ul style="list-style-type: none"> • Sample loop is filled with a very small amount of sample and transport liquid or wash solution (mobile phase). • Very high precision • No loss of sample



Most important factors in injection are precision, accuracy and carry-over. They are effected by the injection technique and equipment and for manual injection also by the user.

Autosampler AS 6.1L for automated injection

The AZURA Autosampler AS 6.1L is a high precision device available for a maximum back pressure of 1240 bar. This autosampler can inject from up to 768 positions when equipped with microtiter plates or from up to 108 standard 2 ml sample vials. This device is equipped with an ILD™ valve, consisting of a rotor-stator combination with a central port for depressurizing the sample loop before receiving the sample. This way, the sample is not diluted with solvent. The AS 6.1L is available with a pressure rating of 1240 bar, a more cost effective version with a pressure rating of 862 bar and as a preparative or biocompatible version.

- Up to 1240 bar (862 bar)
- Cooling/heating option (4 - 40 °C)
- 0.1 µl - 5000 µl (depending on configuration) sample injection volume
- Up to 768 samples (microtiter plates) or 108 standard vials
- Intermediate Loop Decompression - ILD™

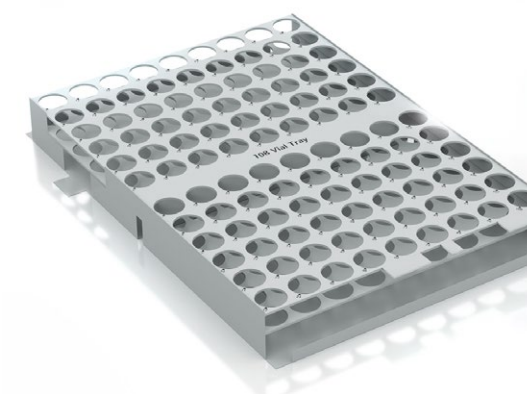
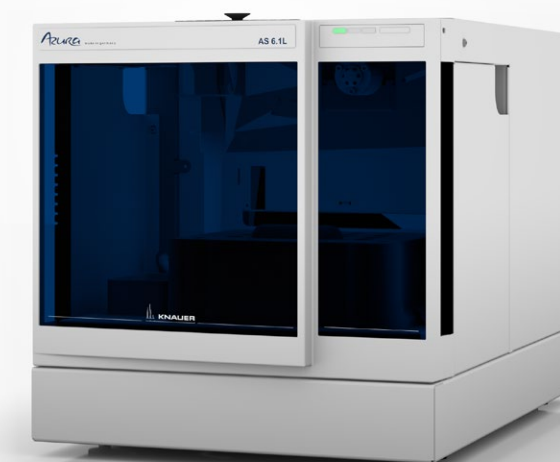

Rack for 108 standard 2 ml vials



The Integrated Intermediate Loop decompression valve reduces sample dilution and increases measurement reproducibility.

Column tempering and switching

Column Thermostat CT 2.1

The AZURA CT 2.1 is a forced air column thermostat capable of heating or cooling from 5 to 85 °C. The powerful fan and robust peltier element keep the column at a very stable temperature, thus allowing reproducible analysis results.

Be flexible with KNAUER valves

KNAUER valves are designed for a wide range of chromatographic applications. Flexibility is provided by choice of different materials and sizes as well as drivers for various software packages.

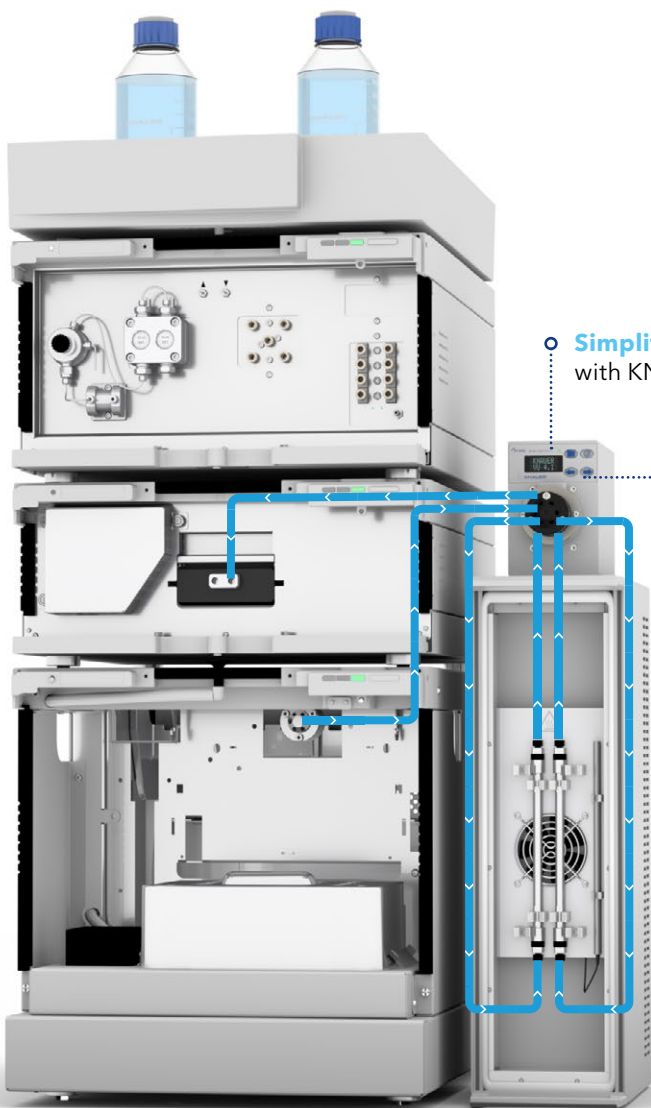

Simplified column switching with KNAUER valves

Valves are driven either manually or automatically through a valve drive.

Column thermostats are an essential part of each HPLC system since most HPLC separation parameters are temperature-sensitive. Hence, the control of the column temperature is one of the most important prerequisites for reproducible results in HPLC.

Wide space, easy handling

Up to 6 columns with maximum 300 mm length

Columns up to 16 mm ID

Cooling and heating from 5 - 85 °C

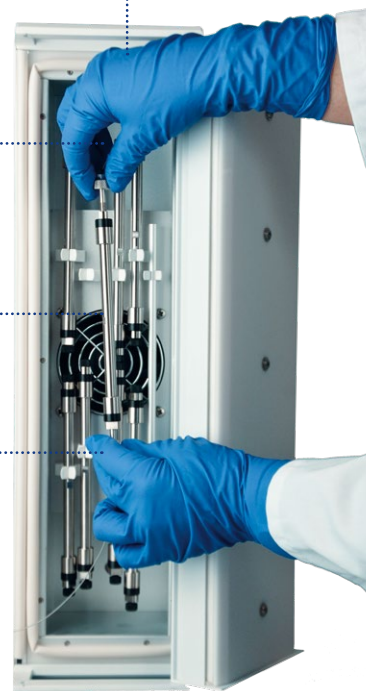

Eluent pre-column tempering

When running HPLC at temperatures above 40 °C, a significant temperature gradient within the column is always present when mobile phase pre-heating is not applied in air-conditioned laboratories.

This device will converge solvent temperature with column temperature before entering the column and will therefore reduce temperature gradients within the column.

The Eluent pre-heating cartridge can easily be retrofitted to the oven chamber of the CT 2.1 by any enduser by just connecting 2 screws.

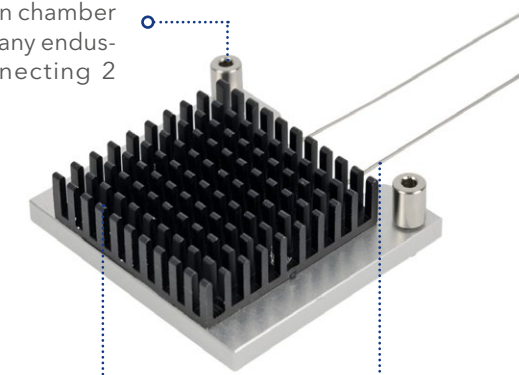
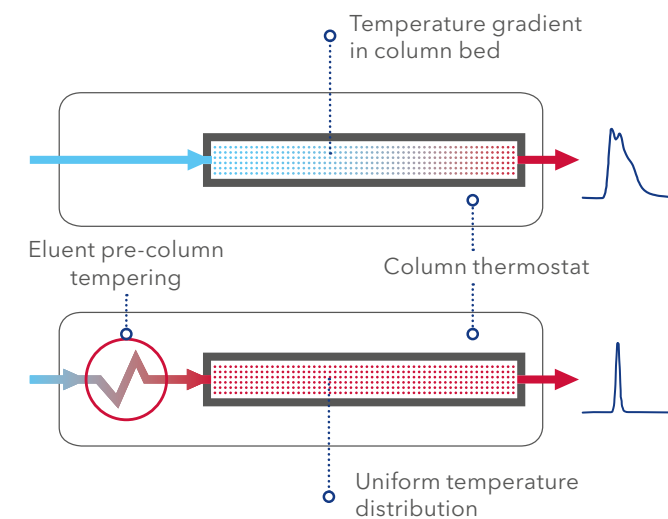

Eluent pre-heating cartridge for CT 2.1

Available with 0.10 or 0.18 mm inner diameter (5 µl/18 µl inner volume)

Rule of thumb

For flow rates higher than 500 µl/min or temperatures above 50 °C, the use of a pre-heating cartridge is recommended.

K-Connect fittings and capillaries

Flexible capillaries and finger-tight connections provide easy handling while ensuring high pressure stability. Precision manufactured surfaces and edges significantly enhance fluid transfer.

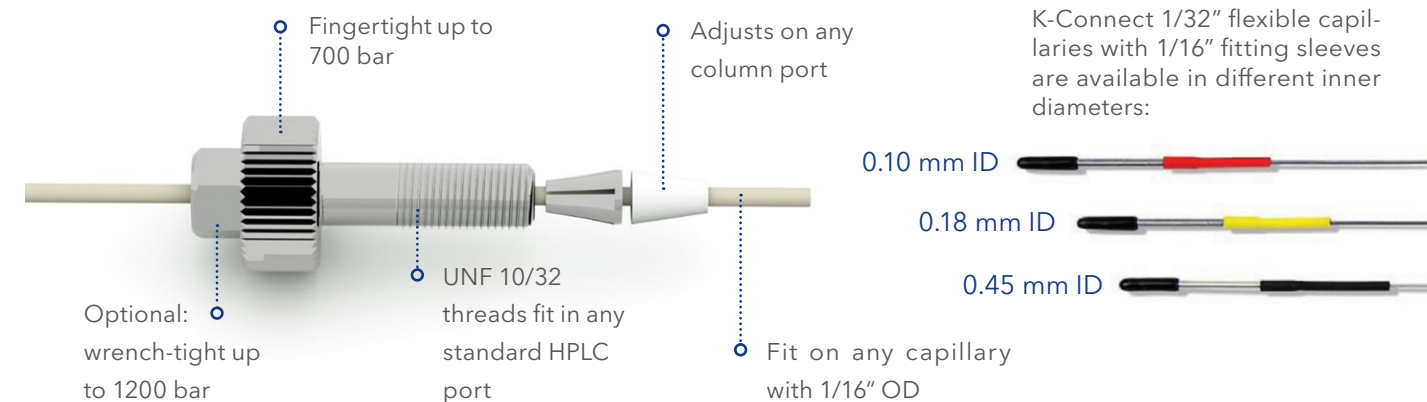

K-Connect 1/32" flexible capillaries with 1/16" fitting sleeves are available in different inner diameters:

0.10 mm ID

0.18 mm ID

0.45 mm ID

Columns for HPLC and UHPLC



STAY FLEXIBLE

Any commercially available standard HPLC column can be used in an AZURA analytical system. KNAUER HPLC columns are compatible with any LC system.



BE SAFE

Find the matching guard column solution for your analytical column and extend its lifetime even if more aggressive eluents or samples are used.

FIND YOUR PERFECT MATCH

We offer a wide range of stationary phases for nearly every application field.



MAKE IT SIMPLE

Easiest up- and downscaling with the same selectivity in many different particle- and column dimensions as well as pressure ranges.



Which column dimensions are recommend?

While the stationary phase always depends on the application, the recommended column dimensions are mainly dependent on the pump integrated in your AZURA analytical system:

Analysis	AZURA pump	Typical column dimensions
Classical HPLC	P 6.1L 862 bar	250 x 4 mm ID / 250 x 4.6 mm ID, 5 µm
HPLC Plus	P 6.1L 862 bar	150 x 3 mm ID, 3 µm
UHPLC	P 6.1L 1 000 bar	100 x 2 mm ID, 2 µm



Smaller column dimensions

=

Shorter analysis time

=

Higher back pressure and performance

Liquid Handler LH 8.1 for complex analytical LC

Experience a new dimension of automation in analytical sample introduction with the Liquid Handler LH 8.1 from KNAUER

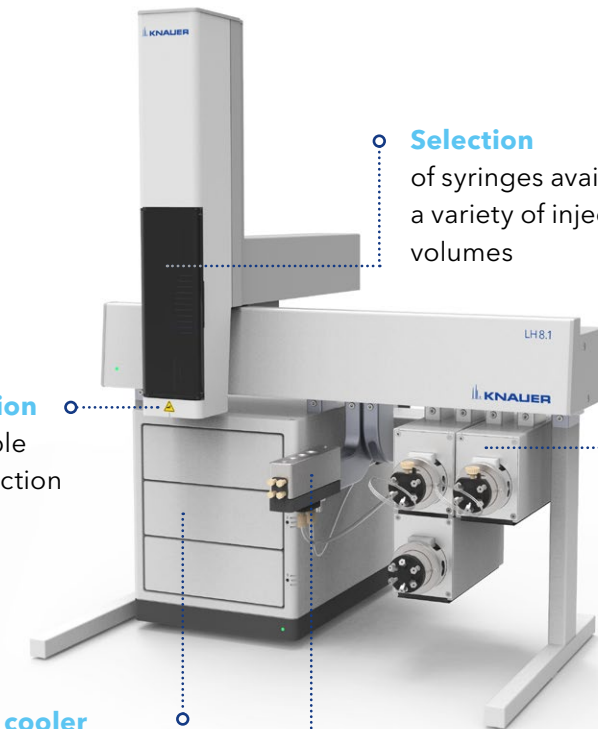

Selection of syringes available for a variety of injection volumes

Sandwich injection enables 0% sample loss and high injection precision

Modular design allows for high adaptability

Robotic cooler for up to 390 2ml vials. Rapid injections through software control

Fast high performance washing station with two different wash solvents minimizes carry-over

Features

- Automates complex chromatography tasks through high flexibility
- Loss-free sample feed with very high injection precision
- Versatile autosampler for high-throughput applications

HPLC/UHPLC of small molecules: Silica based phases: Eurosphere II

Modification	USP code
C18 P	L1
C18 H	L1
C18	L1
C18 A	L1
Phenyl	L11
C8	L7
C8 A	L7
C4	L26
NH ₂	L8
CN	L10
HILIC	-
Diol	L20
Si	L3

Nonpolar phases:
RP

Polar phases:
NP & HILIC

Highest flexibility

13 different modifications are available for a wide range of small molecule applications (< 2000 Da)

- Reversed phase mode for samples, soluble in water and water/organic solvent mixes
- Normal phase mode for water insoluble samples
- HILIC mode for highly polar and water soluble samples that are not retained by RP chromatography
- Ion pair chromatography for acids and bases that are poorly retained in RP mode

KNAUER columns for the determination of biomolecules: Eurosil Bioselect

Why do I need wide pores?

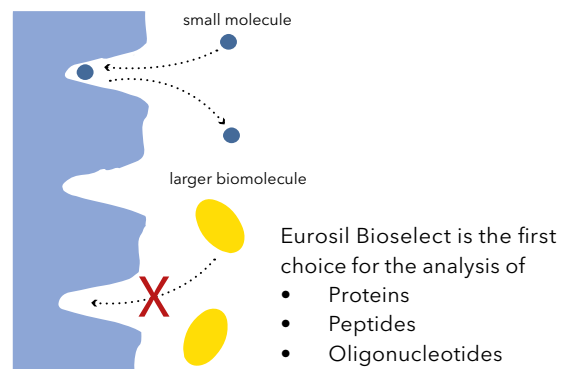

Which modification should I choose?

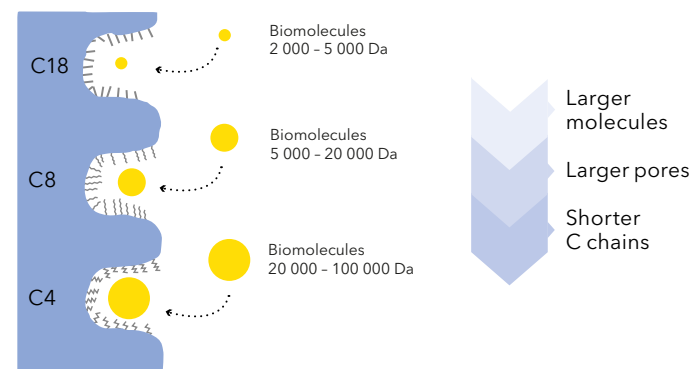

HPLC of sugars, organic acids and alcohols: Eurokat

A complex separation consisting of ligand exchange, ion exclusion, ion exchange, size exclusion and partition mechanisms. Based on a sul-

fonated cross-linked styrene-divinylbenzene copolymer, 4 ionic forms are available for special applications:

H	Sugars, organic acids and alcohols
PB, Ca	Small carbohydrates (mono- and disaccharides)
Na	Sugar oligomers (up to DP 8)

Eurokat is ideal for the **organic solvent free** analysis of:

- Fruit beverages
- Soft drinks
- Wine
- Beer
- Fermentation broths

Detection

When do I use which detector? The detection technique depends on the characteristics of the analyte.

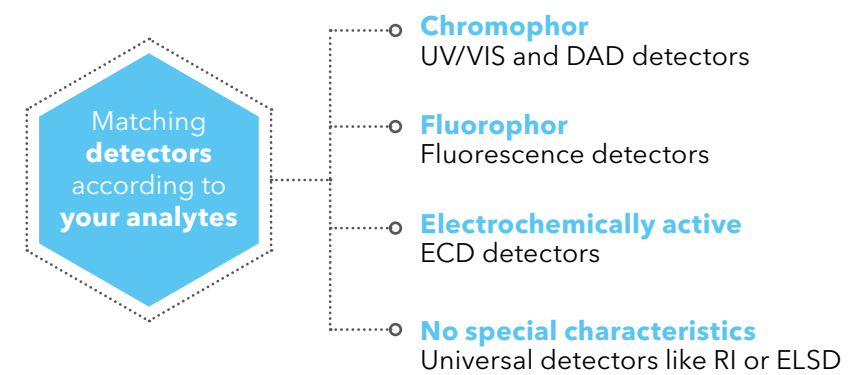

Variable or multiple wavelength detectors (MWD or VWD)

Classical UV detectors record 2D data as a chromatogram. These devices are called VWD or MWD. Nevertheless, 3D-like measurements can be done by scanning the wavelength range. VWD or MWD detectors cannot record 3D data over the whole analysis time but just in programmed time frames.

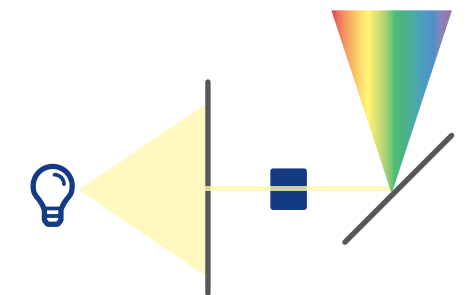

Diode array detectors (DAD or PDA)

Devices called DAD or PDA detectors are able to record 3D data in addition to the 2D data over the whole analysis time.

3D data means that full UV spectra are measured and these spectra are plotted over the whole time. This is useful for unknown analytes or target compounds with different UV characteristics. Additionally 2D chromatograms can be extracted from 3D-data at any wavelength.

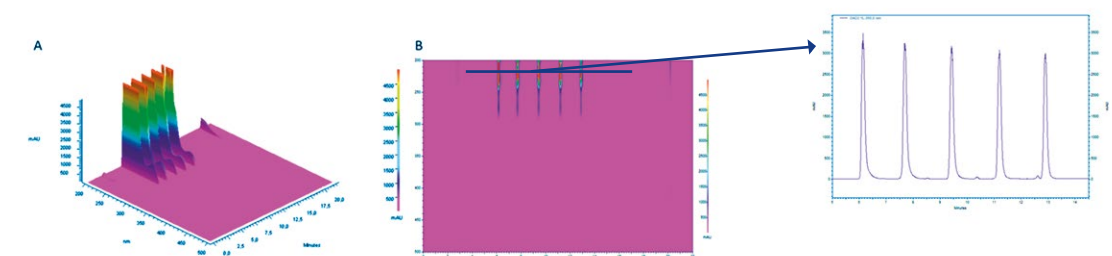

Special detection

Highly sensitive and specialized detectors

Fluorescence detection

These detectors allow to develop highly selective methods with sensitivities three to six orders of magnitude greater than UV detection.

- + Very sensitive method
- + Easy handling
- Only for fluorescent molecules

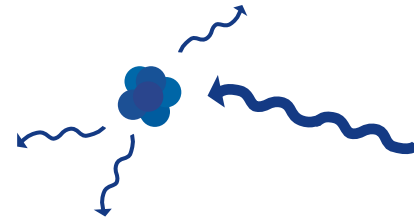

Electrochemical detection

Very sensitive, selective detection of oxidizable/reducible compounds. In amperometric electrochemical detection the electrical current is measured resulting from oxidation or reduction reactions.

- + Very sensitive method
- + Lowest LODs
- Only for special applications
- Handling is not for beginners

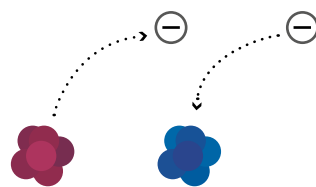

Universal detection

Refractive index detection (RI)

RI detection is a cost-effective solution for the analysis of sugars, polymers, surfactants and other compounds that do not contain a chromophore. These detectors measure the ability of analyte molecules to bend or refract light.

- + UV absorbing solvents usable
- + Very price attractive
- + Easy to use
- No gradient elution
- Comparably low sensitivity

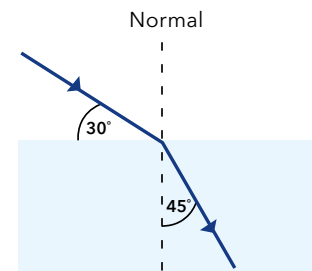

Evaporative light scattering detection (ELSD)

As an universal detector, an ELSD offers numerous possibilities for detecting substances that have few or no chromophores. Since the eluents are evaporated, the use of non-UV-compatible solvents poses no problems and the ELSD is gradient compatible.

- + Gradient elution possible
- + Comparably high sensitivity
- Comparably cost-intensive
- Very clean solvents needed
- Nitrogen source needed
- Not suitable for volatile compounds

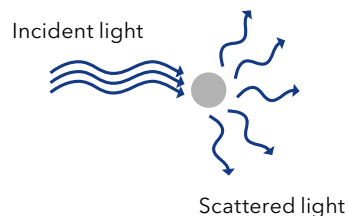

Sensitive UV/VIS detectors

Choose between single variable wavelength, multiple variable wavelength and 3D diode array detectors.

Single variable wavelength detectors

AZURA® UVD 2.1L

Target analytes: Molecules carrying a chromophore, all analytes in a sample that absorb at the same wavelength



Modern detectors can record data rates up to 100 Hz or even more. These high data rates are needed in very fast UHPLC. For classical HPLC, 20 or 50 Hz are typically sufficient.

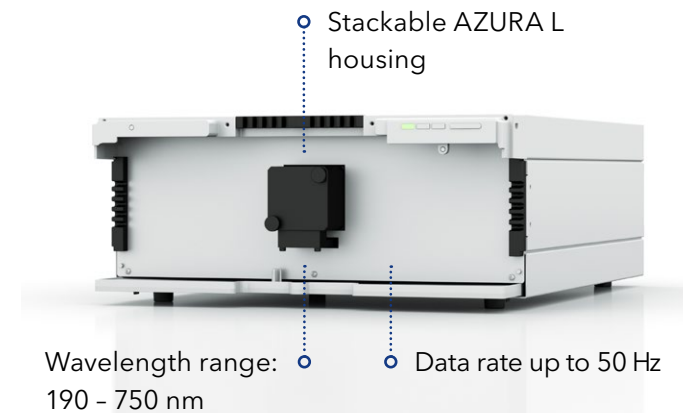

Multiple variable wavelength detectors and diode array detectors

AZURA® MWD 2.1L, DAD 2.1L and DAD 6.1L

Target analytes: Molecules carrying a chromophore, adsorption at different wavelengths or for method development

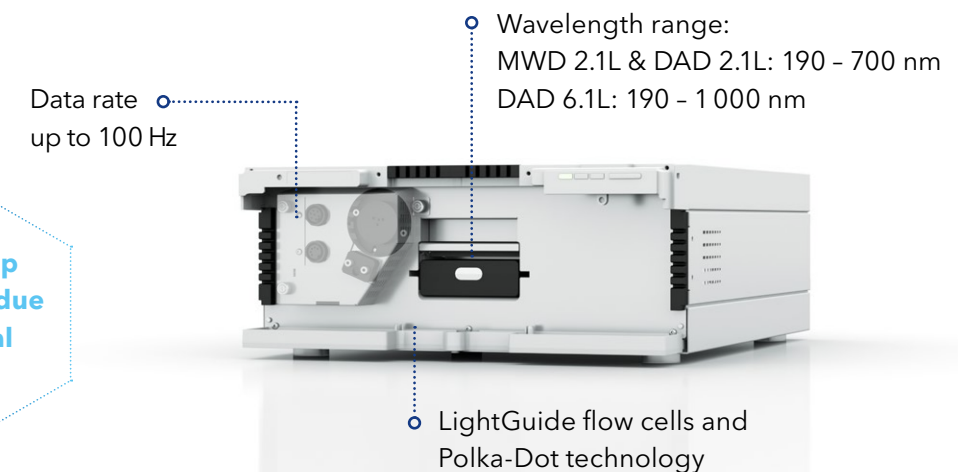
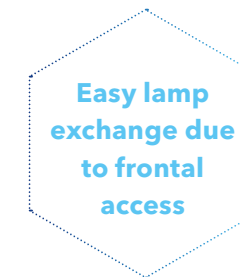

Flow cell cartridges for MWD and DAD detectors

PressureProof Flow cells

- Price attractive and robust
- Possibility to couple a second detector or LC dimension caused by the pressure stability up to 300 bar
- Also suited for higher flow rates up to 20 ml/min

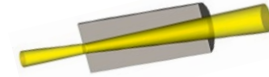

LightGuide Flow cells

- Total reflection technology for high sensitivity
- Minimized cell volume for high resolution

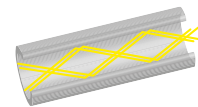

Comparison of flow cells with 10 mm path length: PressureProof vs. LightGuide

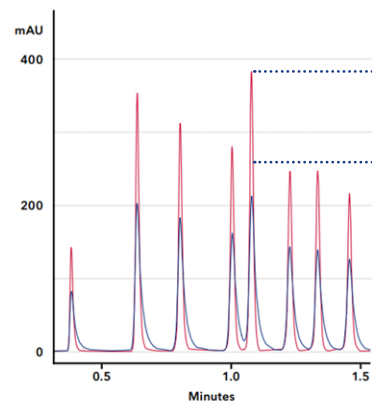

- Higher peaks with LightGuide caused by total reflection technology
- Sharper peaks with LightGuide caused by lower cell volume



The great advantage of LightGuide flow cells and their low dispersion volume seen in UHPLC does not play a major role in classical HPLC as the complete system dispersion volume is much larger.

Blue: Analytical PressureProof
Red: Standard LightGuide

Comparison of LightGuide flow cells: Standard vs. High Sensitivity

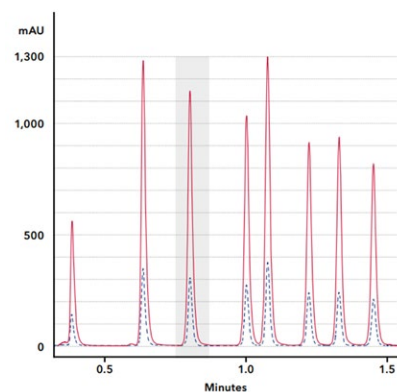

Blue: Standard LightGuide with 10 mm path length
Red: High Sensitivity LightGuide with 50 mm path length

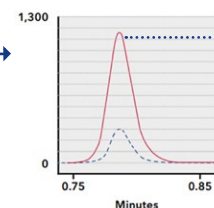

- Peaks get around 4 times higher with Lightguide High Sensitivity flow cell

Which flow cell fits your application best?

Analysis	Typical HPLC column dimension	Main objective	Recommended flow cell
Classical HPLC	250 x 4 mm ID / 250 x 4.6 mm ID, 5 µm	Robust method	Analytical PressureProof
		High sensitivity	High sensitivity LightGuide
HPLC Plus	150 x 3 mm ID, 3 µm	Robust method	Analytical PressureProof
		High resolution and fast runs	Standard LightGuide
UHPLC	100 x 2 mm ID, 2 µm	High resolution and fast runs	Standard Lightguide
		High sensitivity	High sensitivity LightGuide
Micro and Nano LC	100 x 0.3 mm ID, 5 µm 50 x 0.075 mm ID, 3 µm	Lowest volume	Nano flow cell with fiber optics



KNAUER flow cells in cartridge design are very easy exchangeable by just clicking them out without any tools.

Remote flow cells

Separate the flow cell spatially from the detector via fiber optic cables in a distance up to 10 meters.

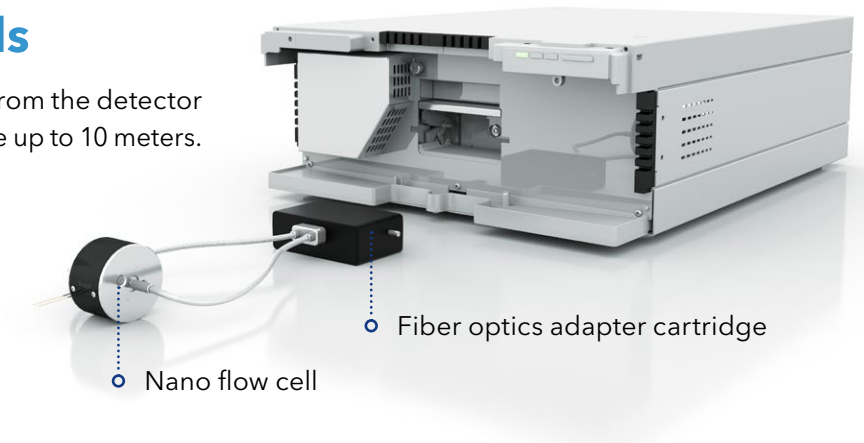

• Nano flow cell

• Fiber optics adapter cartridge

Universal detectors

AZURA® RID 2.1L

The AZURA RID 2.1L is a highly competitive and sensitive refractive index detector, ideal for fast and reliable routine analysis of non-UV absorbing substances. The intelligent temperature control guarantees fast baseline stabilization and stable operation.

Target analytes: Alcohols, sugars, saccharides, fatty acids and polymers

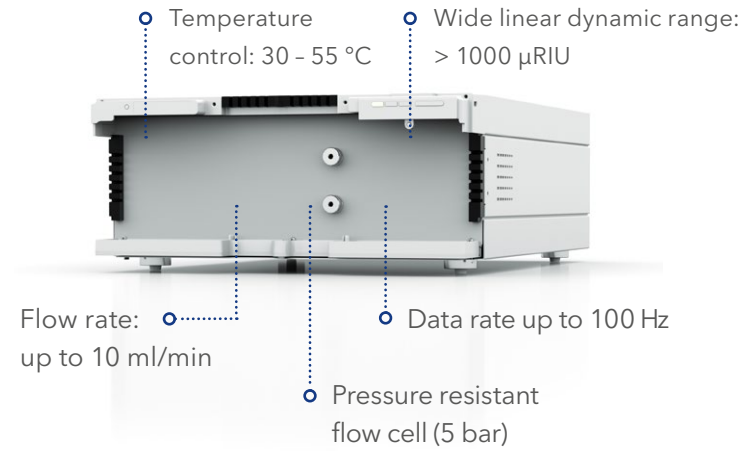

Light Scattering Detector Sedex 85LT, Sedex 90LT and Sedex 100LT
Sensitive universal detection with the possibility to run gradients



As an universal detector, an ELSD offers numerous possibilities for detecting substances that have few or no chromophores. Since the eluents are evaporated, the use of non-UV-compatible solvents poses no problems and the ELSD is gradient compatible.

Target analytes: Carbohydrates and similar compounds, detergents, ionic and non-ionics, artificial sweeteners, antioxidants, amino acids, lipids, peptides, polymers, pesticides, proteins, steroids



ELSD is a good replacement for a Charged Aerosol Detector (CAD). Just choose the right fitting nebulizer and get the best out of the ELSD for your analyte detection.

Special detectors

One of the smallest single variable wavelength detectors on the market

AZURA® UVD 2.1S

The AZURA UVD 2.1S offers excellent technical specifications for routine laboratory work. With its small footprint, it is one of the smallest detectors for HPLC on the market.

Highly competitive UV detector

Wavelength range: 190-500 nm



Fluorescence Detector RF-20A

The fluorescence detector RF-20A provides world-class sensitivity, excellent maintainability and diverse validation/support functions. It supports a wide range of applications in the wavelength range of 200 to 650 nm from conventional analysis to high-performance analysis.

Target analytes: Fluorescent molecules like polycyclic aromatic hydrocarbon, fluorescence tagged analytes like amino acids or proteins.



Interface Box IFU 2.1 LAN

The KNAUER interface box IFU 2.1 LAN allows highly precise analog data acquisition of third party modules over analog and relay outputs. Example: MALS-detectors for molecular weight determination.



Software

Mobile Control

KNAUER's monitoring and control software for AZURA® devices and systems

With the hand-held Mobile Control (Chrom) option you have your AZURA devices at your fingertips. Remotely control and monitor your system and enjoy the touchscreen-optimized user interface. Choose Mobile Control as an easy-to-use and cost-effective software solution!

Mobile Control

Mobile Control provides full access to AZURA devices. Change device settings, set operating parameters, automate device control or check the system status... Mobile Control features all functionalities of a display. Do you want more than a display without using an advanced chromatographic data system?

Mobile Control Chrom

Mobile Control Chrom features data acquisition from AZURA detectors in addition to full device control.

OpenLAB® CDS EZChrom Edition

OpenLAB CDS EZChrom Edition is the next generation of chromatography data systems. It provides chromatography data acquisition, processing and control of GC and LC chromatographs and is used in chromatography operations ranging from single user/single instrument to multi-user/multi-instrument laboratories.

ClarityChrom® CDS

ClarityChrom is an easy-to-use chromatography data system for workstations. The optional GPC- and Knauer FRC control modules and extensions for PDA, SST, SEC/GPC and MS allow using the software for a wide range of applications.

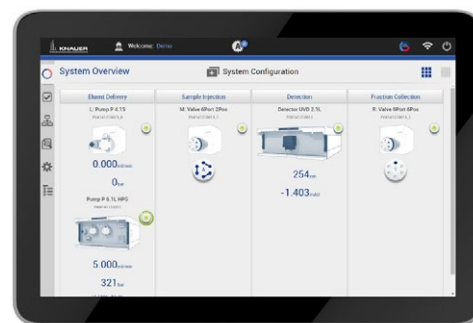





Chromeleon™ 7.2 Drivers

Thermo Scientific™ Dionex™ Chromeleon™ is one of the most wide-spread chromatography data systems. Its intuitive handling benefits laboratory workflow and the highly developed algorithms simplify data processing. It offers a broad range of third-party drivers and can be easily used with existing HPLC systems. KNAUER offers drivers for a lot of its devices.



AZURA® Analytical HPLC systems

Product	Features	Page
AZURA Analytical UHPLC system 	This system features a AZURA P 6.1L HPG pump, an autosampler 6.1L, a column thermostat CT 2.1, a DAD 6.1L UV/VIS detector with 8-variable UV measuring channels from 190-1 000 nm, as well as a Tablet PC with Mobile Control. It is the UHPLC system with a backpressure range of 1000 bar. It perfectly fits the demanding needs of a method development system, as well as the robust fitness of a routine analysis machine.	26
AZURA Educational system 	Complete isocratic analytical HPLC system, UV/VIS detector with one variable wavelength, pump unit with pressure sensor for a low pulsation eluent supply, optional Mobile Control software allows direct control of all integrated modules.	27
AZURA Analytical HPLC/UHPLC system 	Efficient and adaptable - with ULDC option. KNAUER AZURA liquid chromatography instruments are designed to support and facilitate your work. Whether doing routine analysis or demanding separation tasks, AZURA systems are the right tool to overcome your analytical challenges. Choose between different gradient forming technologies and maximum flow rates to find the best configuration for your task. A large variety of detectors is available.	28
AZURA LC column test system 	The basic system configuration of the AZURA LC column test system consists of an isocratic pump, an autosampler, a column selection assistant and a variable single wavelength UV detector as well as the customizable chromatography software including the column test option.	29
AZURA sugar system 	HPLC up to 862 bar in isocratic version, 10 ml pump head, refractive index detector, column thermostat, manual injection via an injection valve, Mobile Control for monitoring and control of the integrated modules, ClarityChrom CDS for instrument control, data acquisition and data processing.	30

Polyphenol analysis in chocolate

Determination of 14 compounds in 1.5 minutes using the AZURA® UHPLC system

UHPLC for quality control of dark chocolate

- Polyphenols and alkaloids like caffeine or theobromine

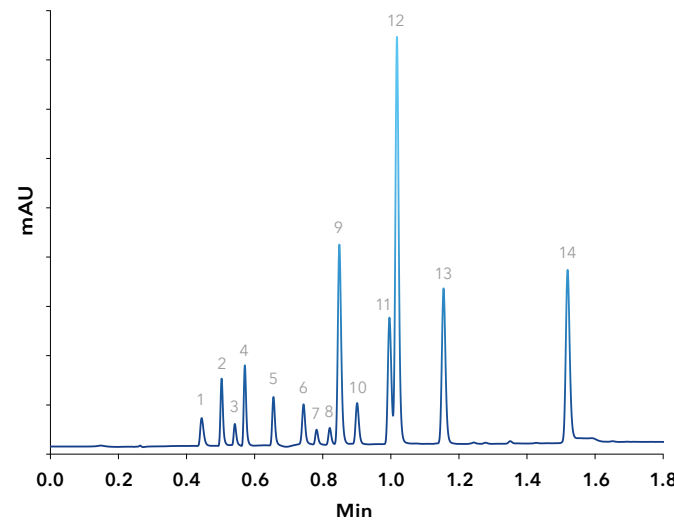

1 Acesulfam K; 2 Theobromine; 3 Saccharin; 4 Theophylline; 5 Caffeine; 6 Chlorogenic acid; 7 Catechin; 8 Epicatechin; 9 4-Hydroxybenzoic acid; 10 Vanillin; 11 Guaiacol; 12 Sorbic acid; 13 Methylparaben; 14 Propylparaben

UHPLC system

Analytical HPG configuration with DAD detection



Devices	Key features
AZURA Pump P 6.1L	HPG pump, 0.001-5 ml/min, sst, max. 1000 bar
AZURA Detector DAD 2.1L	Diode array detector, D ₂ lamp, 190-700 nm, max. 100 Hz
AZURA Column Thermostat CT 2.1	Forced air column thermostat, 5 - 85 °C
AZURA Auto-sampler AS 6.1L	Analytical autosampler, 0.1 µl - 5 ml injection volume, cool/heat option, 108 vial positions, max. 1240 bar

How do you explain HPLC? AZURA® Educational system

For tomorrow's HPLC professionals

Your AZURA Educational System includes printed training material that explains several applications of HPLC. For example, the quantitative determination of caffeine and paracetamol in samples of your choice (e.g. coffee, soft drinks, medicine) is explained in detail.



In simple steps, students are introduced to basic concepts and terms used in HPLC such as calibration curve and internal standard. The easy to understand instructions guide them through the complete experiment, including setup, run and analysis.

What is included?

Devices	Key features
HPLC system AZURA Educational System	AZURA Compact HPLC with pump P 4.1S and detector UVD 2.1S with flow cell (10 mm path length, 1/16" connectors)
Sample application	Manual injection valve including 10 µl sample loop, HPLC injection syringe (straight needle) & mounting bracket
Start-up kit AZURA	Capillaries and fittings (PEEK, 1/16")
Accessories	Eluent tray E 2.1L set of mobile phase bottles (2 x 1000 ml) tool kit for HPLC system setup
PC	Laptop with pre-installed Windows
PC communication	Router for LAN connection (8 x)
Software for controlling and recording	ClarityChrom® software and licence for the AZURA Compact HPLC system
HPLC Column	Eurospher II 100-5 C18 with integrated precolumn, 125 mm x 4 mm ID, magnetic clip to attach column

ULDC TECHNOLOGY



Ultra Low Dispersion Chromatography, short ULDC, makes use of the reduction of the system volume to enhance the separation by improvement of e.g., peak shape/width, resolution, and signal-to-noise ratio. A comparison of different system volumes was performed to show the effect of extra column dispersion on system performance.

Azura® 862



- **ULDC** - Ultra low dispersion chromatography
Ultra low dispersion volume due to optimized injection, flow and detection
- Conventional method easily transferred
- Sharper peaks mean better sensitivities and resolutions
- Faster elution leads to faster methods and higher sample throughput
- **AZURA 862** easily upgradable towards ULDC
- Up to 20-30% improvement
- ULDC technologie stands for optimized components
- Easy and cost effective way to tune an AZURA 862 HPLC
- All AZURA systems can be upgraded

HPLC system for automated LC column testing

Automated quality control of up to 8 columns

Dedicated HPLC system and user interface simplify column performance tests.

Once started, the automated column testing requires no further support. For overnight measurements, results are available the next morning. Alternatively, column tests can be performed continuously.

After the quality test, a test certificate displaying the column and method specifications, the chromatogram and the result table is generated for each column. The design and content of the column test report can be customized. An easily

editable parameter list manages the specifications and test methods of several thousand columns, so that the right method for a column test can easily be chosen via the column specification. An intelligent search allows a quick selection of the desired column in the software. For a fast and intuitive operation, the column test option features an own user interface. The number of clicks to setup the test sequence has been reduced to a minimum.

Sugar system for the determination of sugar monomers

Honey and its substitutes

- Differentiate between natural honey and possible substitutes of food industry
- Determination of sugar monomers like fructose (1), glucose (2), sucrose (3) and maltose (4)
- Highest reproducibility in shortest time

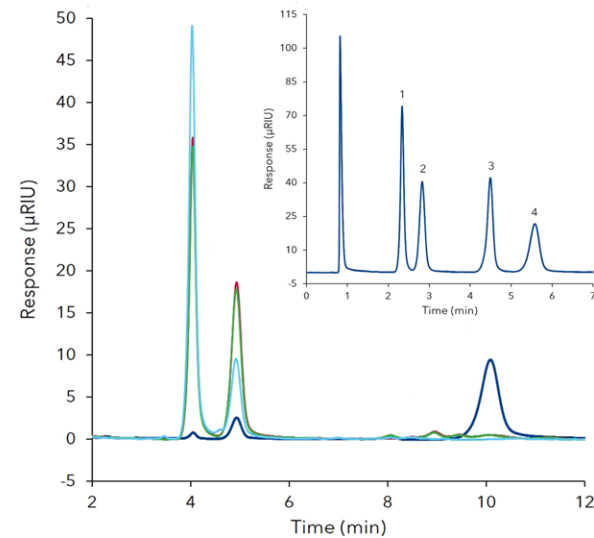

HILIC amino phase for fast and high resolution separation of sugars.

Overlay of 12 replicates of the sugar standards and different honey and honey substitute samples.



Devices	Key features
AZURA Pump P 6.1L	LPG pump, 0.001-10 ml/min, sst, max. 862 bar
AZURA Detector RID 2.1L	Refractive index detector, max. 5 bar, max. 100 Hz
AZURA Column Thermostat CT 2.1	Forced air column thermostat, 5-85 °C, 2 °C/min
AZURA Valve V 2.1	6 port 2 pos injection valve, 1/16", sst, 1 200 bar
Vertex Plus column Eurospher II NH2	150x4 mm, 100 Å, 3 µm

Accessories

AZURA Eluent Tray E 2.1L

The eluent tray E 2.1L for AZURA devices with a capacity of 6 x 1000 ml bottles is stackable onto all AZURA devices. The inlay is removeable for cleaning. The eluent tray possesses a drainage system and a removable front that facilitates access to a capillary guide.



AZURA Inlet Tubing Kit with solvent filter

The AZURA Tubing Kit with solvent filter (stainless steel, 10 µm) is suitable for all analytical HPLC systems (isocratic, HPG, LPG). The filter can be used with all flow rates of the pump heads provided.



Safety caps

Why should I use safety caps?

- Stop the liquid flow line via stopcocks whenever no flow is delivered. Be safe from eluent loss!
- Filters and air-inlet valves prevent the eluent from evaporating and result in maximized stability of retention times due to stable eluent composition.
- Filters at the waste bottle keep the air around your AZURA system clean.



Technical data

AZURA Pump P 6.1L	Low pressure gradient HPLC Plus	Low pressure gradient UHPLC	High pressure gradient HPLC Plus	High Pressure gradient UHPLC
Max. flow rate	10 ml/min	5 ml/min	10 ml/min	5 ml/min
Flow rate range	0.001 - 10 ml/min	0.001 - 5 ml/min	0.001 - 10 ml/min	0.001 - 5 ml/min
Flow rate increment	0.001 ml/min	0.001 ml/min	0.001 ml/min	0.001 ml/min
Maximum delivery pressure [psi]	10 150 psi	14 500 psi	10 150 psi	14 500 psi
Maximum delivery pressure [bar]	862 bar	1 000 bar	862 bar	1 000 bar
Maximum delivery pressure [MPa]	86 MPa	100 MPa	86 MPa	100 MPa
Pump head materials	Stainless steel	Stainless steel	Stainless steel	Stainless steel
Gradient	Low pressure gradient (quaternary)	Low pressure gradient (quaternary)	High pressure gradient (binary)	High pressure gradient (binary)
Leak management	Yes	Yes	Yes	Yes
Best working conditions	0.1 - 8.0 ml/min	0.02 - 5 ml/min	0.1 - 8.0 ml/min	0.02 - 5 ml/min
Continuous working conditions	0.1 - 4.0 ml/min	0.1 - 4.0 ml/min	0.1 - 4.0 ml/min	0.1 - 4.0 ml/min

AZURA Pump P 8.1L	
Pump type	Analytical UHPLC pump
Delivery system	Dual serial piston pump
Pulsation compensation	Active pulsation reduction
Piston seal washing	Active wash
Flow rate range	0.001-5 ml/min
Max. delivery pressure	18 000 psi / 1 240 bar / 124 MPa
Flow rate accuracy	0.5 %* ¹
Flow rate precision	≤ 0.05% RSD or 0.01 min SD* ²
Pulsation	≤ 0.5% or 2 bar amplitude* ³
System protection	P _{min} and P _{max} are programmable
Gradient range	0-100 % in 0.1 % increments
Solvent selection valve	2 x 2 channels
Gradient formation	High pressure gradient / Binary pump
Gradient accuracy	+/- 0.35 %**
Gradient precision	≤ 0.15 % RSD or 0.01 min SD*
Degasser channels	4 channels
Purge valve	Automatic purge
Leak sensor	Yes
Wetted materials	Stainless steel, sapphire, ruby, PEEK, zirconium oxide, nickel cobalt-chromiummolybdenum alloy (MP35N®), diamond-like carbon (DLC), polyimide (Vespe®), polyethylene

* water, 1 ml/min at 1 200 bar

** 0.2-3 ml/min for water, methanol acetonitrile

¹ <1% at 1 ml/min or 10 µl* at all pressures > 10 bar for water, acetonitrile and methanol

² <0.1 % RSD or 0.05 SD* for water, acetonitrile, and methanol (based on retention time at constant temperature)

³ 1 % or 5 bar amplitude at 1 ml/min at all pressures > 10 bar for water, methanol and acetonitrile

Technical data

AZURA Column Thermostat CT 2.1	
Heating and cooling system	microprocessor controlled Peltier element for heating and cooling, fan supported 2-way air circulation
Temperature range	5 - 85 °C
Heating/cooling rate	2 °C/min
Temperature accuracy	± 0.2 °C
Temperature stability	± 0.1 °C
Dimensions, interior	90 x 390 x 47 mm (W x H x D)
Safety	self-check and auto-calibration at power-on, selectable turn-off temperature

AZURA Autosampler AS 6.1L		
Method	HPLC Plus	UHPLC
Autosampler Flow Path	Analytical	Analytical
Maximum back pressure	862 bar	1240 bar
Vial/plate dimensions	max. plate/vial height: 47 mm (incl. septa or capmat)	max. plate/vial height: 47 mm (incl. septa or capmat)
Injection volume range	0.1 µl - 5 ml depending on sample loop	0.1 µl - 5 ml depending on sample loop
Sample loop	100 µl	100 µl
Dispenser syringe	250 µl	250 µl
Headspace pressure	built-in compressor, only for sample vials with septum	built-in compressor, only for sample vials with septum
Switching time inj. valve	< 100 ms	< 100 ms
Piercing needle precision	± 0.6 mm	± 0.6 mm
Vial detection	missing vial/well plate detection by sensor	missing vial/well plate detection by sensor
Needle wash	programmable: wash between injections and wash between vials	programmable: wash between injections and wash between vials
Wetted materials	Tefzel® (ETFE), Glass, Teflon® (PTFE), Kel-F® (PCTFE), stainless steel, PEEK	Tefzel® (ETFE), Glass, Teflon® (PTFE), Kel-F® (PCTFE), stainless steel, PEEK
Injection modes	full loop filling, partial loop filling and microliter pickup	full loop filling, partial loop filling and microliter pickup
Injection precision	RSD (Relative Standard Deviation): full loop: <0.3% partial loop: <0.5% (injection volume >5 µl) microliter pickup: <1.0% (injection volume >5 µl)	RSD (Relative Standard Deviation): full loop: <0.3% partial loop: <0.5% (injection volume >5 µl) microliter pickup: <1.0% (injection volume >5 µl)
Sample carryover	<0.0015%	<0.0015%
Injections per vial	max. 9 injections	max. 9 injections
Injection cycle time	minimum 7 s from the same vial, 14 s from different vials; < 60 s for >100 µl sample injection in all injection modes, incl. 300 µl needle wash	minimum 7 s from the same vial, 14 s from different vials; < 60 s for >100 µl sample injection in all injection modes, incl. 300 µl needle wash
Analysis time	max. 9 h, 59 min, 59 s	max. 9 h, 59 min, 59 s
Tray Tempering	Optional (4-40°C)	Optional (4-40°C)

Technical data

AZURA Detector	DAD 2.1L	DAD 6.1L
Detector type	Diode array detector	Diode array detector
Number of diodes	256	1024
Pixel pitch	2 nm/diode	0.8 nm/diode
Detection channels	8 (Digital)/4 (Analog)	8 (Digital)/4 (Analog)
Light source	Deuterium (D ²) lamp with integrated GLP chip	High brightness deuterium (D ²) lamp and halogen lamp with integrated GLP chip
Wavelength range	190 - 700 nm	190 - 1000 nm
Spectral bandwidth	<10 nm at Ha line (FWHM) /Note: digital bandwidth 1 - 32 nm	< 3.5 nm at Ha line (FWHM) /Note: digital bandwidth 1 - 32 nm
Wavelength accuracy	± 1 nm	± 1 nm
Noise	± 5 µAU at 254 nm	± 3.5 µAU at 254 nm
Drift	400 µAU/h at 254 nm	300 µAU/h at 254 nm
Linearity	> 2.0 AU at 274 nm	> 2.5 AU at 274 nm
Maximum data rate	100 Hz (LAN)/12.5 Hz (analog)	100 Hz (LAN)/12.5 Hz (analog)
Flow cell	Not included (see Accessories / Spare parts)	Not included (see Accessories / Spare parts)
Time constants	0.00 / 0.01 / 0.02 / 0.05 / 0.1 / 0.2 / 0.5 / 1.0 / 2.0 / 5.0 / 10.0 s	0.00 / 0.01 / 0.02 / 0.05 / 0.1 / 0.2 / 0.5 / 1.0 / 2.0 / 5.0 / 10.0 s
Integration time	Automatic	Automatic

AZURA Detector	MWD 2.1L	UVD 2.1L	UVD 2.1S
Detector type	Variable multiwave-length detector	Variable single wave-length UV detector	Variable single wave-length UV detector
Detection channels	8 (Digital)/4 (Analog)	1	1
Light source	Deuterium (D ²) lamp with integrated GLP chip	Deuterium (D ²) lamp with integrated GLP chip	Deuterium (D ²) lamp with integrated GLP chip
Wavelength range	190 - 700 nm	190 - 750 nm	190 - 500 nm
Spectral bandwidth	< 10 nm at Ha line (FWHM) /Note: digital bandwidth 1 - 32 nm	11 nm at Ha line (FWHM)	13 nm at Ha line (FWHM)
Wavelength accuracy	± 1 nm	± 2.5 nm	± 3 nm
Noise	± 5 µAU at 254 nm	± 1.5 x 10 ⁻⁵ AU at 254 nm (ASTM E1657-98)	± 2.0 x 10 ⁻⁵ AU at 254 nm (ASTM E1657-98)
Drift	400 µAU/h at 254 nm	3.0 x 10 ⁻⁴ AU/h at 254 nm (ASTM E1657-98)	3.0 x 10 ⁻⁴ AU/h at 254 nm (ASTM E1657-98)
Linearity	> 2.0 AU at 274 nm	> 2.0 AU at 270 nm (ASTM E1657-98)	> 2.0 AU at 270 nm (ASTM E1657-98)
Maximum data rate	100 Hz (LAN)/12.5 Hz (analog)	50 Hz (LAN)/20 Hz (Analog)	50 Hz (LAN)/20 Hz (Analog)/10 Hz (RS-232)
Flow cell	Not included	Not included	Not included
Time constants	0.00 / 0.01 / 0.02 / 0.05 / 0.1 / 0.2 / 0.5 / 1.0 / 2.0 / 5.0 / 10.0 s	0.0 / 0.1 / 0.2 / 0.5 / 1.0 / 2.0 / 5.0 / 10.0 s	0.00 / 0.02 / 0.05 / 0.1 / 0.2 / 0.5 / 1.0 / 2.0 s

AZURA Detector	RID 2.1L
Detector type	Refractive index detector
Light source	Long-life LED
Detection channels	1
Refractive index range	1.00 - 1.75 RIU
Noise	± 2.5 nRIU
Drift	200 nRIU/h
Linearity	> 1000 µRIU
Flow cell	5 bar back pressure resistance Flow cell included
Maximum flow rate	10 ml/min (pure water)
Flow cell volume	15 µl
Wetted materials	Stainless steel / fused silica / PTFE / PEEK
Temperature control	OFF, 30 - 55 °C (1 °C increment)
Time constants	0.00 / 0.01 / 0.02 / 0.05 / 0.1 / 0.2 / 0.5 / 1.0 / 2.0 / 5.0 / 10.0 s
Maximum data rate	100 Hz (LAN)/20 Hz (Analog)



Based in Berlin, KNAUER is a medium-sized, owner-managed company that has been serving the sciences since 1962. We develop and manufacture scientific instruments of superior quality for liquid chromatography. The range includes systems and



Worldwide partner in science since 1962

components for analytical HPLC/UHPLC, preparative HPLC, fast protein liquid chromatography (FPLC), multi-column chromatography/simulated moving bed (SMB), osmometry and Skids for the production of lipid nanoparticles (LNP).

Independent and family owned



It all started with a soldering iron, a jigsaw and an ingenious idea for a highly accurate electronic thermometer.

Chemist Dr.-Ing. Herbert Knauer founded the company together with his wife Roswitha in 1962. Both are still active as advisers to this day. The couple's daughter, Alexandra Knauer, is managing

director and owner of the company since the year 2000. As of April 2021, she is leading KNAUER together with Sales Director Carsten Losch.

Today, KNAUER is an established company with 180 employees that successfully develops, manufactures and markets chromatography instruments worldwide.

think **LNP**. think **KNAUER**.

Disclaimer: Technical data or prices are subject to change without notice. Prices may vary by country and do not include taxes, customs duties or delivery. All trademarks are the property of their respective owners. Our general terms and conditions apply: www.knauer.net/terms.

System configurator

HPLC/UHPLC by KNAUER

MAKE YOUR PRESELECTION

- UHPLC**
(SST, max. 1000 bar)
- HPLC**
(SST, max. 700 bar)
- Bio-Inert**
(metal-free, max. 400 bar)

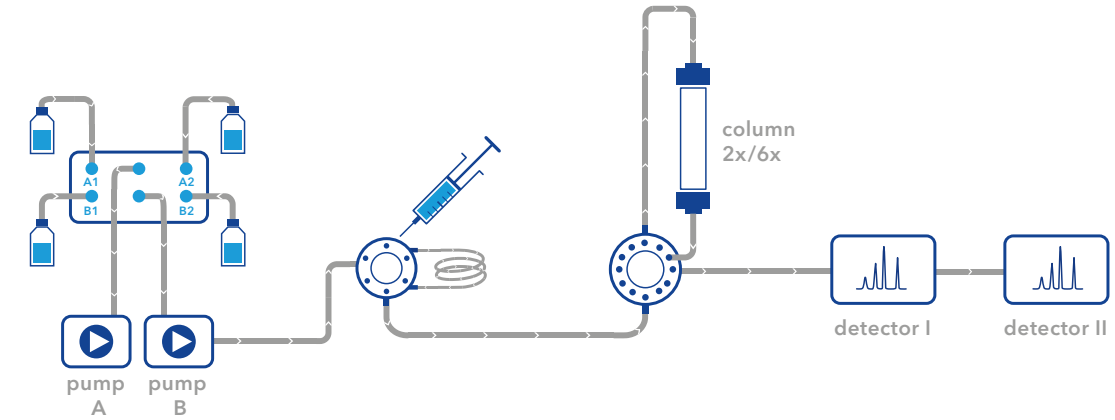

ELUENT SELECTION & DELIVERY

- 5 ml/min binary gradient pump P 6.1L (UHPLC)
- 5 ml/min quaternary gradient pump P 6.1L (UHPLC)
- 10 ml/min binary gradient pump P 6.1L
- 10 ml/min quaternary pump P 6.1L
- 5 ml/min binary gradient pump P 8.1L (UHPLC)
- x solvent selection valve (6 further inlets)

SAMPLE INJECTION

- Manual injection valve
- Autosampler AS 6.1L
- Autosampler AS 6.1L cool/heat

COLUMN SELECTION & THERMOSTAT

- 2 columns
- 4 columns
- 8 columns
- Column thermostat
- Column kit HPLC
- Column kit UHPLC
- Eluent pre-heating cartridge 0.1 mm ID UHPLC
- Eluent pre-heating cartridge 0.18 mm ID HPLC

DETECTION

- UV/VIS single wavelength
- UV/VIS multiple wavelength
- Conductivity
- pH
- Refractive index
- Light Scattering
- A/D-converter (integration of further detectors)
- DAD 2.1L
- DAD 6.1L
- Fluorescence Detector RF-20 A
- Fluorescence Detector RF-20 Axs

ACCESSORIES

- 0.1 mm tubing
- 0.18 mm tubing
- PEEK tubing
- x Back pressure regulator
- Workstation (Windows)

FLOW CELLS FOR UV-DETECTOR

- 10 mm/10 µl Pressure proof
- 10 mm/2 µl LightGuide®
- 50 mm/6 µl LightGuide®
- 3 mm/2 µl (up to 100 ml/min) Pressure proof

SOFTWARE

- ClarityChrom®
- OpenLAB®
- Chromeleon™
- Mobile Control

COMMON APPLICATIONS

- Reversed phase
- Normal phase
- other...
- System Qualification

KNAUER is the proud winner of the
German Innovation Award 2022 in the
category of medium-sized businesses.

(U)HPLC • Prep. LC • FPLC • SMB • LNP • Osmometry



Innovation

Own hardware and
software development



Customized solutions

Pumps, detectors, valves and
systems adapted to your needs



Made in Germany

Independent and family-
owned since 1962

think **LC.** think **KNAUER.**

KNAUER Wissenschaftliche Geräte GmbH

Hegauer Weg 38 • 14163 Berlin

+49 30 809727-0 • +49 30 8015010 (Fax)

info@knauer.net • www.knauer.net

